

# Shark PRO NANO

## INTERNAL FILTERS

Designed & Produced in Italy

**5** YEAR GUARANTEE  
3+2 WITH ONLINE REGISTRATION

Having adequate filters for a small size aquarium is crucial to keep the livestock healthy. With the new SHARK PRO NANO we are offering the best compact option with EXTRA flow and MAX filtration capacity for small aquariums. Two models simple, linear and sleek design for easy hiding in any corner. They can be upgraded with add on cartridges taking few space but assuring an adequate filtering capacity for crystal water thanks to a multi stage filtration system.

Shark PRO NANO		250	320
Watt	220 - 240 V · 50 Hz	3.5	4
	110 - 120 V · 60 Hz	5.5	6
Max flow rate	l/h	250	320
	US gph	65	85
For aquarium*	L	up to 50	up to 75
	US gal	up to 13.2	up to 20
Cable length	m	2,2	
	ft	7.55	

\*Volumes rated for lightly to moderately stocked freshwater aquarium.



### FOCUS ON



**250**

2 CARTRIDGES INCLUDED

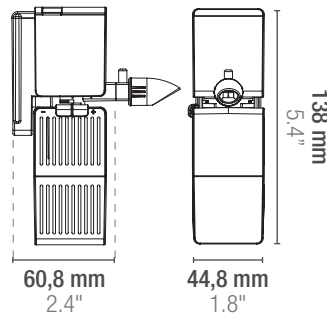

**320**

3 CARTRIDGES INCLUDED

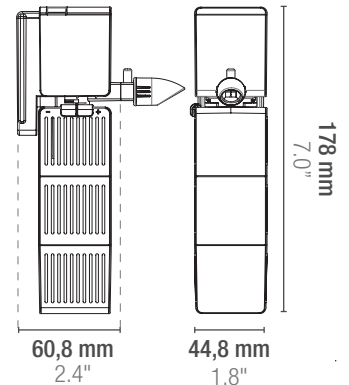

### MULTI-STAGE FILTRATION

MODULAR CARTRIDGE WITH FILTER MEDIA:

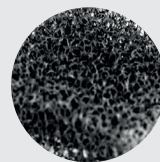

CARBONATED FOAM  
Mechanical filtration

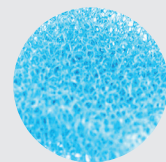

FOAM 30 PPI  
Chemical filtration



95 x 80 x h 190 mm + (40) mm  
3.7 x 3.1 x h 7.5" + (1.6")

### APPLICATIONS



FRESH & MARINE  
AQUARIUM

Flow regulation.



Working also in turtles kit (horizontal positioning).

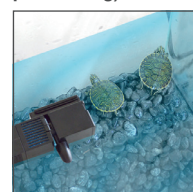

Independent module with filter media.



Kit flow accessories included.



# Shark PRO NANO

INTERNAL FILTERS

Designed & Produced in Italy

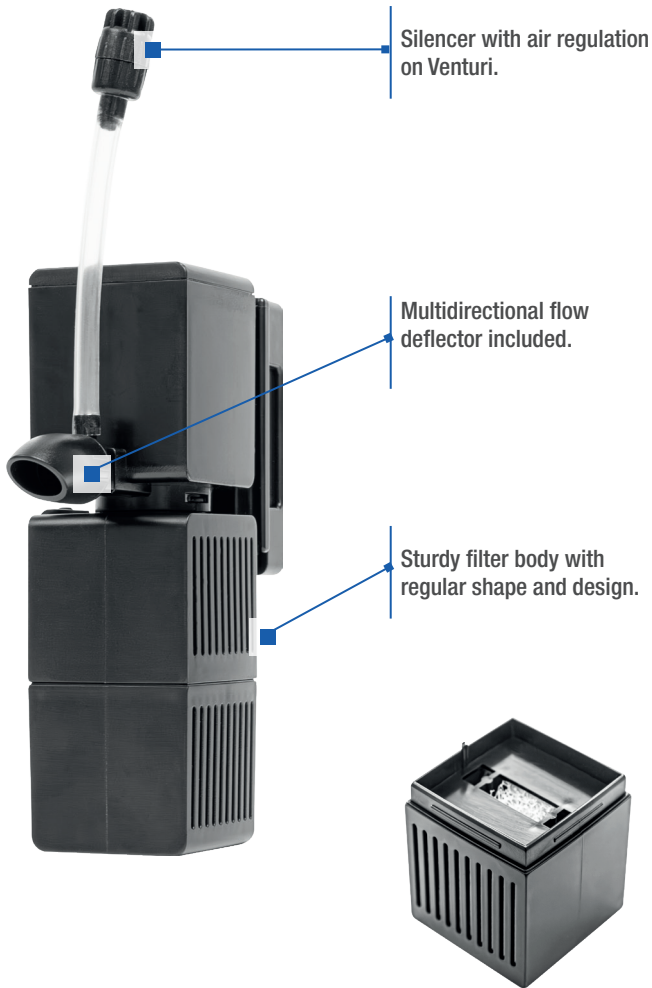

**OPTIONAL**  
Extra cartridges can be added to upgrade filtration volume.

## SPARE PARTS

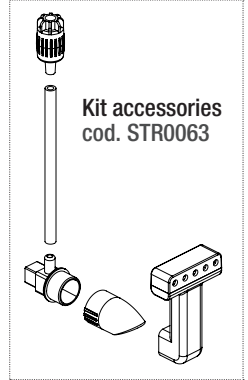
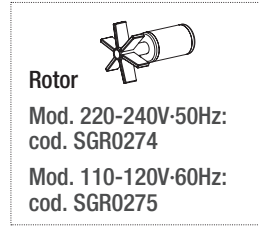
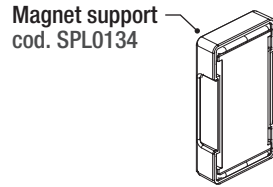

Foams kit  
cod. SSP0047

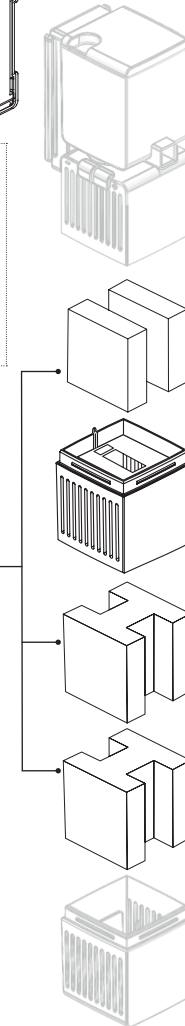

Module with foam  
cod. SVA0025

## 4 WATER FLOW OPTIONS

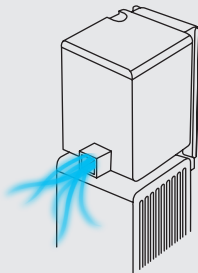

Uni-directional flow

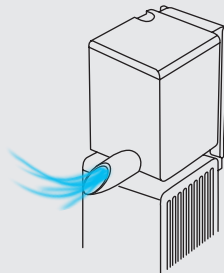

Multidirectional flow

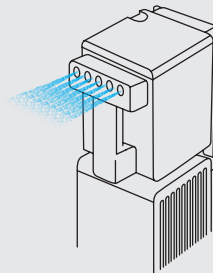

Spray bar

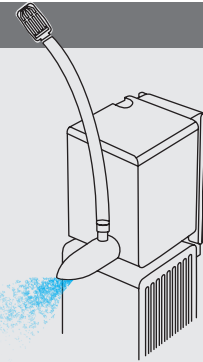

Oxygen enrichment with Venturi